

FINE Vu

FINEPOWER

FinePower250

安全與注意事項

- 請勿隨意拆解或改裝本產品。
- 本產品僅適用於 12V 車輛。
- 請務必使用隨附的 FineVu 原廠保險絲分接器進行安裝。
- 連接保險絲盒時，請務必正確辨識「IN」與「OUT」接頭。
- 連接保險絲盒時，請避開引擎、方向盤等重要系統的保險絲。
- 僅可連接至與車輛運行無直接關聯的附屬保險絲，如車內燈、音響系統、點菸器插頭、天窗、後車廂或電動座椅等。
- 請勿將本產品曝露於陽光直射或接觸到水。

產品組成

組件

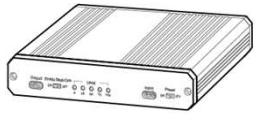

FinePower 250



輸入線
(2 m / 78.7 in)



輸出線
(2 m / 78.7 in)

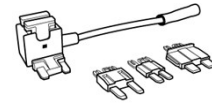

多重保險絲盒線



固定膠帶 (2 片)



使用手冊

選購配件

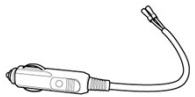

點菸器插頭線
(30 cm / 11.8 in)



Tesla Y 型線



輸入線 (5 m / 196.9 in)

零件名稱

- 強行連接線材可能會造成損壞。連接線材前，請確認各接頭均設定無誤。

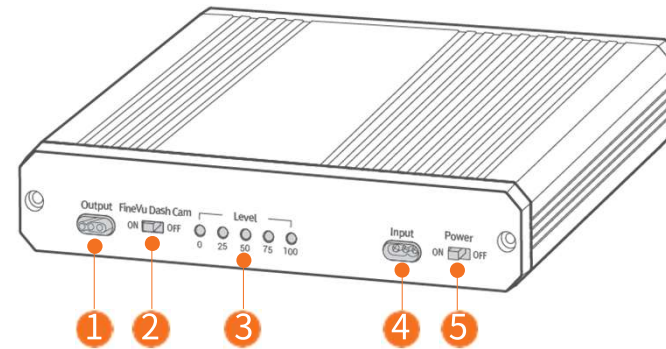

No.	名稱	功能
1	Output	連接輔助電池與行車記錄器。
2	FineVu Dash Cam	<ul style="list-style-type: none"> • 連接 FineVu 行車記錄器時，請將此功能設為「開啟」，以便在 FineVu 應用程式中檢查電池狀態及其他資訊。 • 連接其他品牌行車記錄器時，請設定為「關閉」。否則，某些功能可能無法正常運作。 • 如果輸出線的 ACC 線路連接任何外接配件，請將此功能設為「關閉」。否則，某些功能可能無法正常運作。 • 電池資訊每 5 分鐘更新一次。
3	Level	<ul style="list-style-type: none"> • 電池電量會透過指示燈以五段式顯示：0% / 25% / 50% / 75% / 100%。 • 當剩餘電量低於 20% 時，行車記錄器將切換至「停車節能模式」。（僅支援「停車節能模式」的型號） • 電池電量準確度會隨著充放電機制逐漸提升，因此初次使用時顯示的電量可能略有誤差。
4	Input	連接輔助電池與車輛。 <ul style="list-style-type: none"> • 請使用多重保險絲盒線連接至車輛適當的保險絲位置。 • 點菸器插頭線和 Tesla Y 型線為選購配件，須另行購買。
5	Power	開啟和關閉輔助電池電源。 <ul style="list-style-type: none"> • 如不使用輔助電池，請將「FineVu Dash Cam」和「Power」都設定為「關閉」。否則行車記錄器可能無法正常運作。 • 否則行車記錄器可能無法正常運作。 • 若輔助電池為「關閉」，行車記錄器的停車模式將無法使用。

安裝說明

- 安裝方式可能因車款和安裝位置而有所差異。

保險絲盒安裝方式



點菸器安裝方式

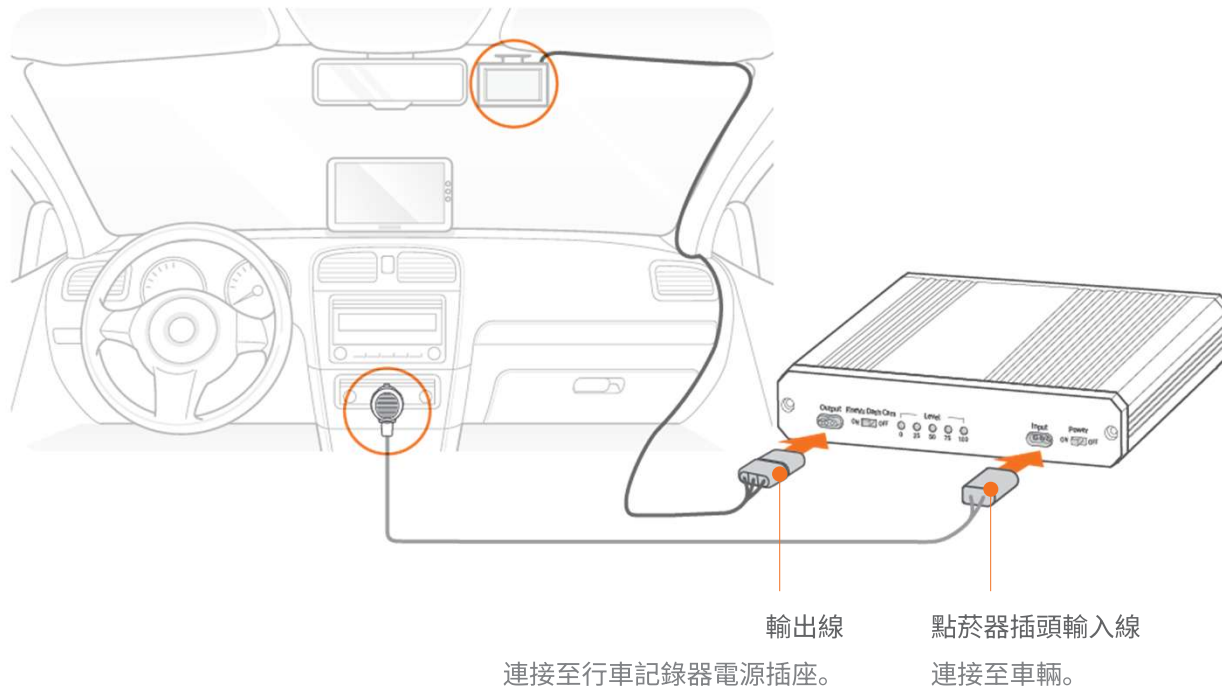

多重保險絲盒線使用方式 (VCC 連接)

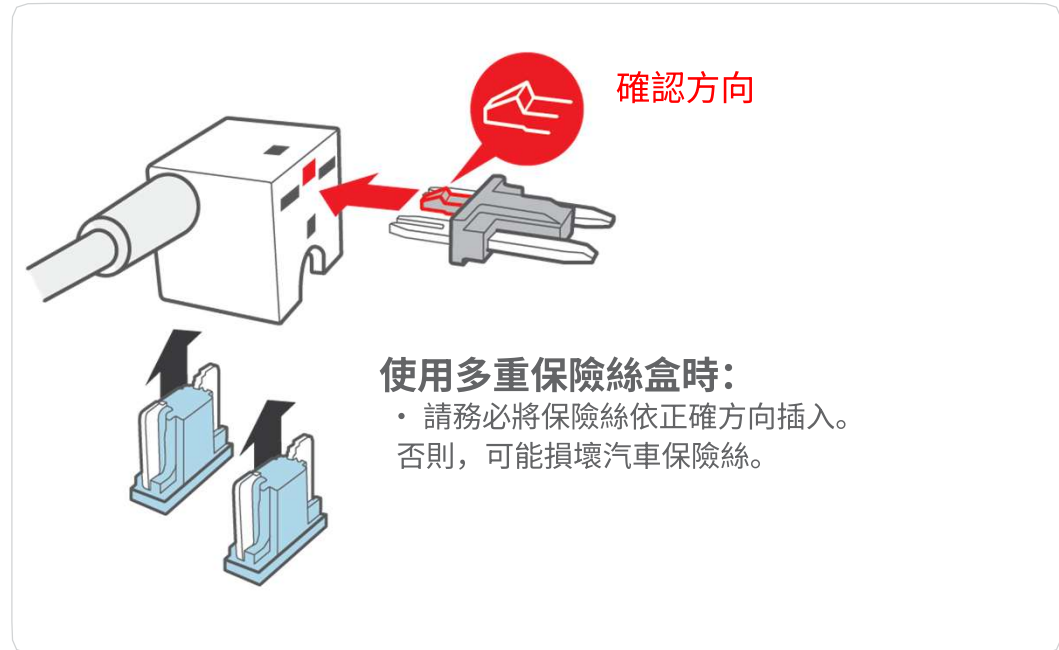
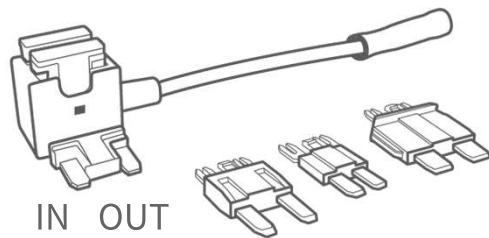
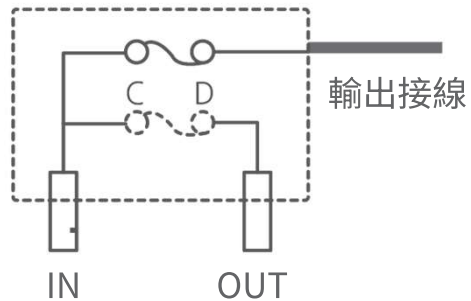

使用多重保險絲盒時：

- 取出保險絲後，請使用測試儀器找到電源輸入接頭 (IN)，並確保將「IN」接頭接到正確位置。安裝錯誤可能損壞車輛原廠保險絲。

若無測試儀器：

- 當多重保險絲盒中的保險絲朝上時，應將左側連接至「IN」，右側連接至「OUT」。
- (請參考上方圖示，安裝時請小心避免損壞車輛的保險絲盒。)

產品規格

產品	規格	備註
型號名稱	FinePower 250	
尺寸 / 重量	135.0 x 175.0 x 32.0mm / 965g (5.3 × 6.9 × 1.3 in / 34.0 oz)	
額定輸出功率	8.6V~12.5V/1A (最大電流: 1.5A)	磷酸鐵鋰電池 9.6V/8A
電池充電時間	約 70 分鐘	
操作溫度	0 ~ 60°C (32 ~ 140°F)	當偵測到 80°C (176°F) 或更高溫度時，系統將自動斷電以保護電池組。
認證	R-R-FDK-FinedriveA039 安全認證: XU103017-22001A 	

* 電池續航時間可能因使用環境而有所差異。

支援型號

電池電量顯示功能支援程度因型號而異。如需詳細資訊，請聯繫 FineVu 客戶服務中心(support@finedigital.com)

產品規格

產品	規格	備註
型號名稱	FinePower 250	
尺寸 / 重量	135.0 x 175.0 x 32.0mm / 965g (5.3 × 6.9 × 1.3 in / 34.0 oz)	
額定輸出功率	8.6V~12.5V/1A (最大電流: 1.5A)	磷酸鐵鋰電池 9.6V/8A
電池充電時間	約 70 分鐘	
操作溫度	0 ~ 60°C (32 ~ 140°F)	當偵測到 80°C (176°F) 或更高溫度時，系統將自動斷電以保護電池組。
認證	R-R-FDK-FinedriveA039 安全認證: XU103017-22001A 	

* 電池續航時間可能因使用環境而有所差異。

支援型號

電池電量顯示功能支援程度因型號而異。如需詳細資訊，請聯繫 FineVu 客戶服務中心(support@finedigital.com)

產品規格

產品	規格	備註
型號名稱	FinePower 250	
尺寸 / 重量	135.0 x 175.0 x 32.0mm / 965g (5.3 × 6.9 × 1.3 in / 34.0 oz)	
額定輸出功率	8.6V~12.5V/1A (最大電流: 1.5A)	磷酸鐵鋰電池 9.6V/8A
電池充電時間	約 70 分鐘	
操作溫度	0 ~ 60°C (32 ~ 140°F)	當偵測到 80°C (176°F) 或更高溫度時，系統將自動斷電以保護電池組。
認證	R-R-FDK-FinedriveA039 安全認證: XU103017-22001A 	

* 電池續航時間可能因使用環境而有所差異。

支援型號

電池電量顯示功能支援程度因型號而異。如需詳細資訊，請聯繫 FineVu 客戶服務中心(support@finedigital.com)

Limited Warranty

FineVu warrants this product to the original purchaser against defects in materials and workmanship under normal use for a period of one (1) year from the date of purchase.

Warranty Coverage

- This warranty applies only to products and accessories purchased from authorized FineVu dealers or resellers.
- It is valid only for the original purchaser and is non-transferable.
- Proof of purchase (such as a receipt or order confirmation) is required to obtain warranty service.
- If a defect is found within the warranty period, FineVu may, at its sole discretion, provide one of the following solutions:
 - Replacement with a new unit;
 - Replacement with a functionally equivalent model;
 - If the original model is discontinued or out of stock, replacement with a refurbished, reconditioned, or pre-owned unit of similar functionality.

Warranty Exclusions

This warranty does not cover the following:

1. Products purchased from unauthorized sellers or unofficial distribution channels.
2. Damage or malfunction resulting from:
 - Misuse, abuse, dropping, impact, or improper storage;
 - Unauthorized disassembly, modification, or repair;
 - Normal wear and tear, or cosmetic damage such as scratches;
 - Use with uncertified third-party accessories or equipment.
3. Failures caused by external factors such as natural disasters, power issues, or abnormal environmental conditions.
4. Any costs related to installation, removal, transportation, or reinstallation of the product or its accessories.

Limitation of Liability

FineVu shall not be held liable for any direct, indirect, incidental, or consequential damages, including but not limited to loss of data, property damage, personal injury or death, or loss of revenue or business opportunities, arising from the use or failure of the product.

- This limited warranty grants you specific legal rights, and you may have additional rights depending on your jurisdiction.

Warranty Service Process

- Customers are responsible for shipping the product to the original place of purchase or an authorized service center at their own expense.
- Replacement products or parts provided under this warranty are covered for 90 days or the remainder of the original warranty period, whichever is longer.

FINE VU

<http://en.finevu.com>

FineVu 客服中心: support@finedigital.com

Limited Warranty

FineVu warrants this product to the original purchaser against defects in materials and workmanship under normal use for a period of one (1) year from the date of purchase.

Warranty Coverage

- This warranty applies only to products and accessories purchased from authorized FineVu dealers or resellers.
- It is valid only for the original purchaser and is non-transferable.
- Proof of purchase (such as a receipt or order confirmation) is required to obtain warranty service.
- If a defect is found within the warranty period, FineVu may, at its sole discretion, provide one of the following solutions:
 - Replacement with a new unit;
 - Replacement with a functionally equivalent model;
 - If the original model is discontinued or out of stock, replacement with a refurbished, reconditioned, or pre-owned unit of similar functionality.

Warranty Exclusions

This warranty does not cover the following:

1. Products purchased from unauthorized sellers or unofficial distribution channels.
2. Damage or malfunction resulting from:
 - Misuse, abuse, dropping, impact, or improper storage;
 - Unauthorized disassembly, modification, or repair;
 - Normal wear and tear, or cosmetic damage such as scratches;
 - Use with uncertified third-party accessories or equipment.
3. Failures caused by external factors such as natural disasters, power issues, or abnormal environmental conditions.
4. Any costs related to installation, removal, transportation, or reinstallation of the product or its accessories.

Limitation of Liability

FineVu shall not be held liable for any direct, indirect, incidental, or consequential damages, including but not limited to loss of data, property damage, personal injury or death, or loss of revenue or business opportunities, arising from the use or failure of the product.

- This limited warranty grants you specific legal rights, and you may have additional rights depending on your jurisdiction.

Warranty Service Process

- Customers are responsible for shipping the product to the original place of purchase or an authorized service center at their own expense.
- Replacement products or parts provided under this warranty are covered for 90 days or the remainder of the original warranty period, whichever is longer.

FINEVu

<http://en.finevu.com>

FineVu 客服中心: support@finedigital.com

產品規格

產品	規格	備註
型號名稱	FinePower 250	
尺寸 / 重量	135.0 x 175.0 x 32.0mm / 965g (5.3 × 6.9 × 1.3 in / 34.0 oz)	
額定輸出功率	8.6V~12.5V/1A (最大電流: 1.5A)	磷酸鐵鋰電池 9.6V/8A
電池充電時間	約 70 分鐘	
操作溫度	0 ~ 60°C (32 ~ 140°F)	當偵測到 80°C (176°F) 或更高溫度時，系統將自動斷電以保護電池組。
認證	R-R-FDK-FinedriveA039 安全認證: XU103017-22001A 	

* 電池續航時間可能因使用環境而有所差異。

支援型號

電池電量顯示功能支援程度因型號而異。如需詳細資訊，請聯繫 FineVu 客戶服務中心(support@finedigital.com)

Limited Warranty

FineVu warrants this product to the original purchaser against defects in materials and workmanship under normal use for a period of one (1) year from the date of purchase.

Warranty Coverage

- This warranty applies only to products and accessories purchased from authorized FineVu dealers or resellers.
- It is valid only for the original purchaser and is non-transferable.
- Proof of purchase (such as a receipt or order confirmation) is required to obtain warranty service.
- If a defect is found within the warranty period, FineVu may, at its sole discretion, provide one of the following solutions:
 - Replacement with a new unit;
 - Replacement with a functionally equivalent model;
 - If the original model is discontinued or out of stock, replacement with a refurbished, reconditioned, or pre-owned unit of similar functionality.

Warranty Exclusions

This warranty does not cover the following:

1. Products purchased from unauthorized sellers or unofficial distribution channels.
2. Damage or malfunction resulting from:
 - Misuse, abuse, dropping, impact, or improper storage;
 - Unauthorized disassembly, modification, or repair;
 - Normal wear and tear, or cosmetic damage such as scratches;
 - Use with uncertified third-party accessories or equipment.
3. Failures caused by external factors such as natural disasters, power issues, or abnormal environmental conditions.
4. Any costs related to installation, removal, transportation, or reinstallation of the product or its accessories.

Limitation of Liability

FineVu shall not be held liable for any direct, indirect, incidental, or consequential damages, including but not limited to loss of data, property damage, personal injury or death, or loss of revenue or business opportunities, arising from the use or failure of the product.

- This limited warranty grants you specific legal rights, and you may have additional rights depending on your jurisdiction.

Warranty Service Process

- Customers are responsible for shipping the product to the original place of purchase or an authorized service center at their own expense.
- Replacement products or parts provided under this warranty are covered for 90 days or the remainder of the original warranty period, whichever is longer.

FINEVu

<http://en.finevu.com>

FineVu 客服中心: support@finedigital.com

Limited Warranty

FineVu warrants this product to the original purchaser against defects in materials and workmanship under normal use for a period of one (1) year from the date of purchase.

Warranty Coverage

- This warranty applies only to products and accessories purchased from authorized FineVu dealers or resellers.
- It is valid only for the original purchaser and is non-transferable.
- Proof of purchase (such as a receipt or order confirmation) is required to obtain warranty service.
- If a defect is found within the warranty period, FineVu may, at its sole discretion, provide one of the following solutions:
 - Replacement with a new unit;
 - Replacement with a functionally equivalent model;
 - If the original model is discontinued or out of stock, replacement with a refurbished, reconditioned, or pre-owned unit of similar functionality.

Warranty Exclusions

This warranty does not cover the following:

1. Products purchased from unauthorized sellers or unofficial distribution channels.
2. Damage or malfunction resulting from:
 - Misuse, abuse, dropping, impact, or improper storage;
 - Unauthorized disassembly, modification, or repair;
 - Normal wear and tear, or cosmetic damage such as scratches;
 - Use with uncertified third-party accessories or equipment.
3. Failures caused by external factors such as natural disasters, power issues, or abnormal environmental conditions.
4. Any costs related to installation, removal, transportation, or reinstallation of the product or its accessories.

Limitation of Liability

FineVu shall not be held liable for any direct, indirect, incidental, or consequential damages, including but not limited to loss of data, property damage, personal injury or death, or loss of revenue or business opportunities, arising from the use or failure of the product.

- This limited warranty grants you specific legal rights, and you may have additional rights depending on your jurisdiction.

Warranty Service Process

- Customers are responsible for shipping the product to the original place of purchase or an authorized service center at their own expense.
- Replacement products or parts provided under this warranty are covered for 90 days or the remainder of the original warranty period, whichever is longer.

FINEVu

<http://en.finevu.com>

FineVu 客服中心: support@finedigital.com